

USER'S GUIDE

EE820 – CO₂ Transmitter for Demanding Applications

GENERAL

The EE820 transmitter is designed for the measurement of CO₂ in demanding applications. It incorporates the E+E dual wavelength NDIR CO₂ sensor, which compensates for ageing effects, is highly insensitive to pollution and offers outstanding long term stability.

For use in special applications do not hesitate to contact E+E Elektronik or a local distributor.

SCOPE OF SUPPLY

- EE820 according to the type number ordered (see ordering guide in the data sheet at www.epluse.com/EE820)
- Test Report according to DIN EN 10204 – 2.2
- Mounting set (screws and rowplugs/screw anchors)
- Mating M12x1 connector for self assembly (only for EE820-CxxxNxx with installed M12x1 connector)

CAUTION

- The transmitter shall not be exposed to extreme mechanical or thermal stress.
- For use in polluted, dirty environment is essential to close tightly the transmitter cover as well as the cable gland or conduit adapter in order to avoid pollution ingress into the enclosure.
- This device is not appropriate for safety, emergency stop or other critical applications where device malfunction or failure could cause injury to human beings.

INSTALLATION/DIMENSIONS

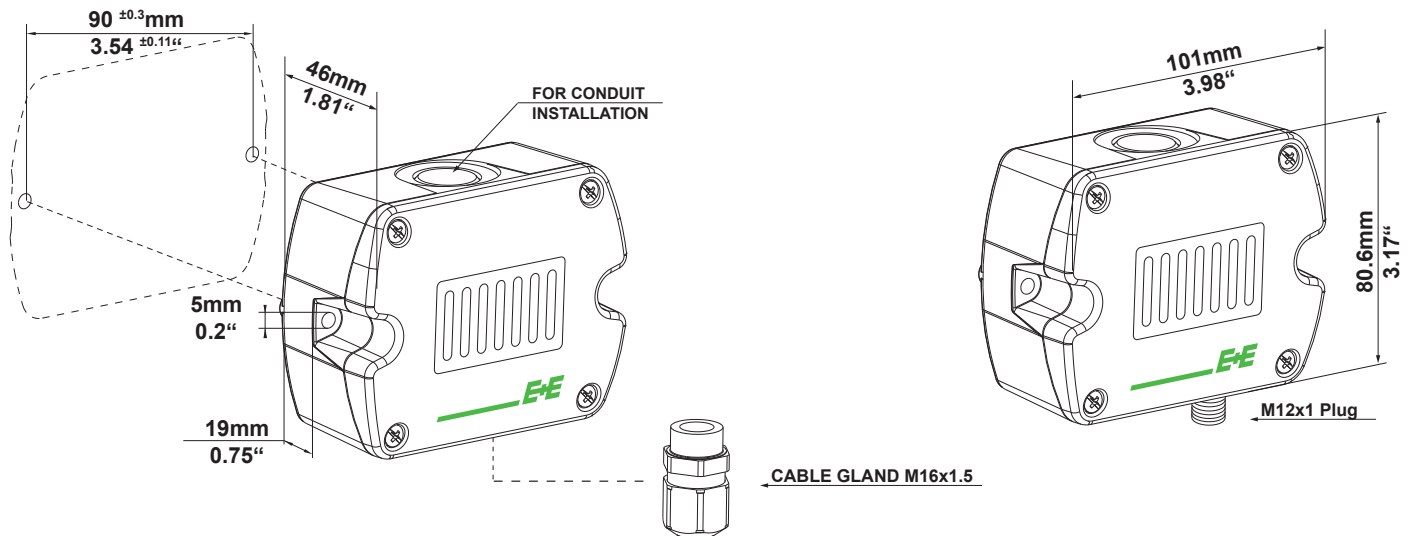

EE820 with M12 plug does not require any wiring inside the device. The external mounting holes allow the device to be mounted without opening the front cover. The mating M12x1 cable plug for self assembly is included in the scope of supply. Please see EE820 data sheet for optional M12 plugs and cables.

EE820 with cable gland: Use a matching wrench to install the cable gland (in the scope of supply) onto the EE820 enclosure. While doing this the blind will knock open. Do not use other, pointed, tools to knock open the blind in order to avoid damaging the electronics inside the enclosure.

EE820 with conduit connection for the North American market: use a flat screwdriver to knock open the blind, carefully, in order to avoid damaging the electronics inside the enclosure. The conduit adapter is not included in the scope of supply.

CONNECTION DIAGRAM

EE820 with M12 plug¹⁾

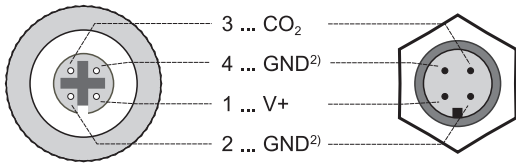

- 1) Mating M12x1 connector for self assembly is included in the scope of supply
2) GND internally connected

EE820 with cable gland

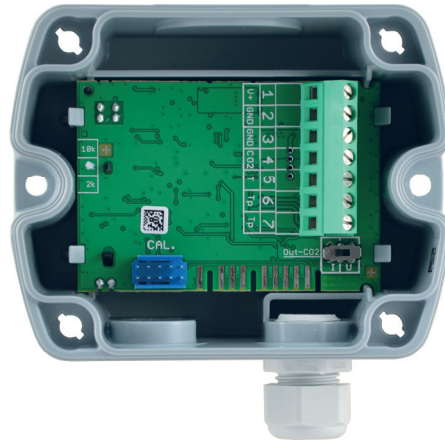
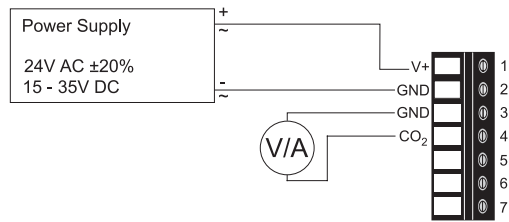

TECHNICAL DATA

(Modification rights reserved)

Measured values

Measuring principle	dual wavelength non-dispersive infrared technology (NDIR)	
Measurement range	0...2000 / 5000 / 10000ppm	
Accuracy at 25°C and 1013mbar (77°F...14,7psi)	0...2000ppm:	< ± (50ppm +2% of measured value)
	0...5000ppm:	< ± (50ppm +3% of measured value)
	0...10000ppm:	< ± (100ppm +5% of measured value)
Response time τ_{63}	standard:	typ. 300s
	fast:	typ. 140s (with a forced air circulation module)
Temperature dependency	typ. 1ppm CO ₂ /°C (-20...45°C) (-4...113°F)	
Sample rate	approx. 15s	

Output

0...2000 / 5000 / 10000ppm	0 - 5 / 0 - 10V	-1mA < I _L < 1mA
	4 - 20mA	R _L < 500 Ohm

General

Supply voltage	24V AC ±20% 15 - 35V DC	
Current consumption	standard:	typ. 15mA + output current
	fast:	typ. 60mA + output current
Current peak	max. 350mA for 0.3s	
Warm up time ¹⁾	< 5 min	
Housing material	Polycarbonate, UL94V-0 approved	
Protection class	IP54	
Electrical connection	Screw terminals 2.5mm ² or M12 plug	
Electromagnetic compatibility	EN61326-1	EN61326-2-3 Industrial Environment
	FCC Part 15	ICES-003 ClassB
Working conditions	-20...60°C (-4...140°F) 0...100% RH (non-condensing)	
Storage conditions	-20...60°C (-4...140°F) 0...95% RH (non-condensing)	

1) for performance according to specification



SETUP AND ADJUSTMENT

The EE820 transmitter is ready to use and does not require any configuration by the user. The factory setup of EE820 corresponds to the type number ordered. For ordering guide please see data sheet at www.epluse.com/EE820

If needed, the user can change the factory setup by using the optional Product Configuration Adapter EE-PCA and the Product Configuration Software EE-PCS. One can change the output signal, the scaling of the output and perform CO₂ adjustment/calibration.

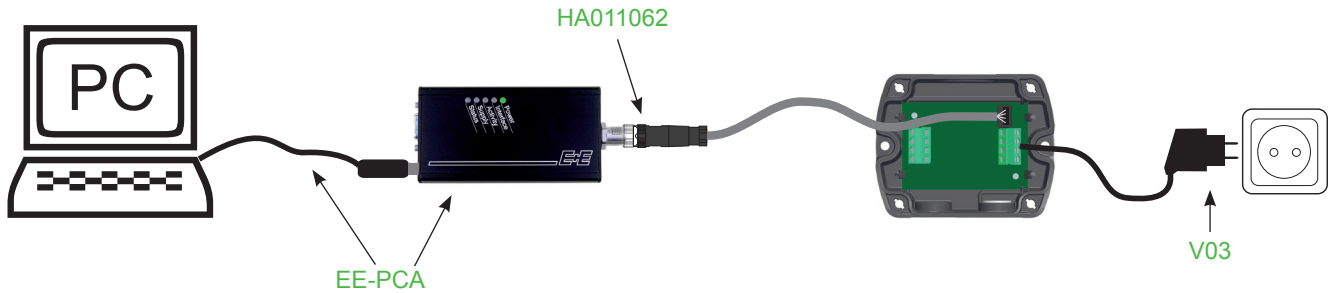

Changing the output signal:

The output signal can be changed from voltage to current or vice-versa.

Set the output signal selection switch to I for current 4 - 20mA output or to U for voltage 0 - 10V output. The original CO₂ output range does not change and the calibration data remains valid.

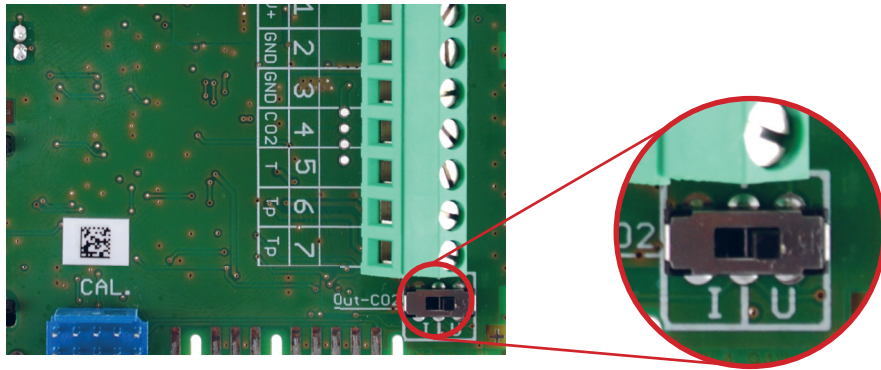

Example:

Factory setup: voltage output (U), output scale: 0 - 10V = 0 - 5000ppm

User setup (after setting the output signal selection switch to I): current output (I), output scale: 4 - 20mA = 0 - 5000ppm.

Changing the output scale:

The scaling of the output can be changed by using EE-PCA and EE-PCS.

Example:

The initial scaling of the output is 4 - 20mA = 0 - 5000ppm. The output scale after the change can be 4 - 20mA = 400 - 4000ppm.

Important:

- After changing the factory setup (output signal and/or output scale) the original type number on the EE820 identification label loses its validity; it does not match any longer the device setup.
- The return to factory setup function of EE-PCS restores the original adjustment/calibration of the device, but does not affect the user setup for output signal and output scale.

For EE-PCA product data sheet please see www.epluse.com/EE820

The EE-PCS Product Configuration Software is available for free download at www.epluse.com/configurator.

MAINTENANCE

Even in case of use in dirty and dusty environment, the electronics of EE820 are very well protected by the enclosure and the filter on the front cover. Do not attempt in any way to clean the inside of the device.

In case of dirt deposits on the exterior of the device, this can be cleaned by weeping it gently with a soft, light wet cloth. The enclosure must be closed during the cleaning. Do not use solvent-based cleaning agents; these might affect the enclosure and the labels. Do not attempt to clean the filter on the front cover, as it would only lead to its faster clogging.

In a polluted environment, the filter on the front cover of EE820 might get clogged in a long run. This is more likely to happen for the EE820 with forced air circulation. Longer response time indicates a clogged filter. In such a case the entire front cover shall be replaced by an original new one.

EE820-FAC - Forced Air Circulation Module (Replacement/Retrofit)

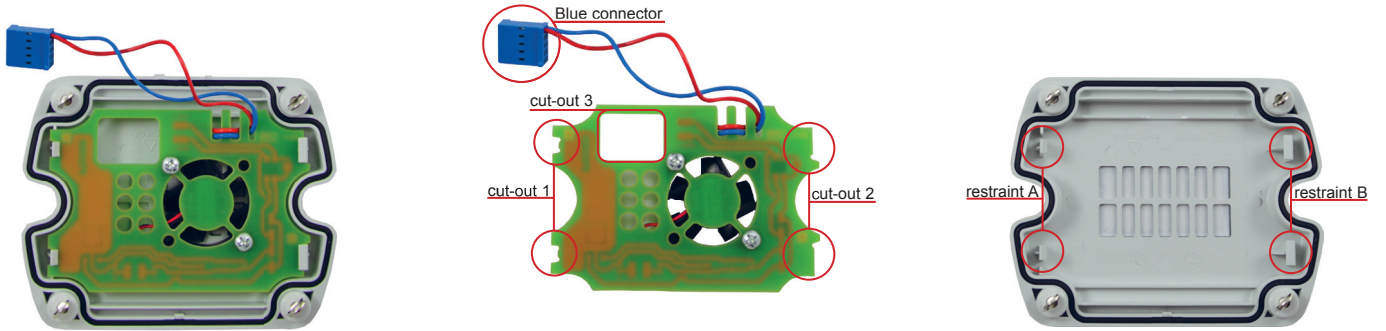

CAUTION

The EE820-FAC Forced Air Circulation Module is an ESD sensitive device and shall be handled at all times according to the general precautions for handling of ESD sensitive equipment .

SCOPE OF SUPPLY

EE820 Cover is not included in the scope of supply and shall be ordered separately, type number: **EE820-COVER**

REPLACING

FOR REPLACING an existing EE820-FAC modul remove first the old EE820-FAC module:

- Disconnect the blue connector from the main EE820 board

1)

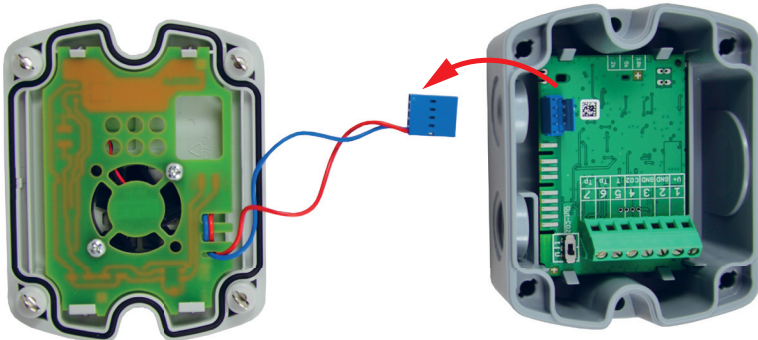

2)

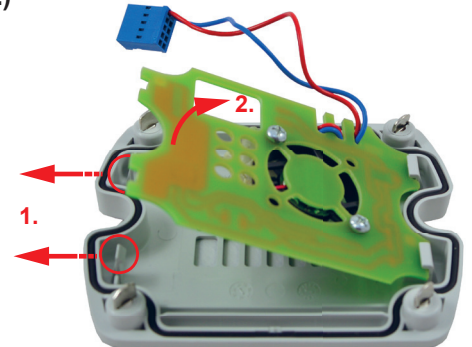

INSTALLING

- Release the old EE820-FAC by acting on restraint A.

For installing the new EE820-FAC:

- Observe the position of the A and B restraints in the cover and of the corresponding cut-outs 1 and 2 in the EE820-FAC board.
- Insert first the EE820-FAC into the B restraints. Then press the EE820-FAC as in the picture , till in snaps into the A restraints.

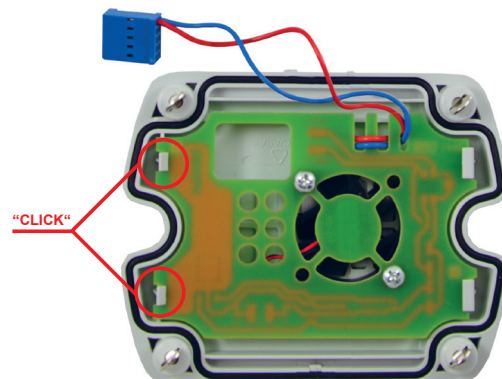
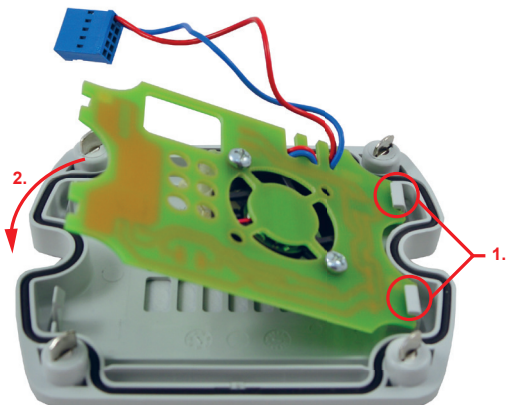

- Connect the blue connector of the EE820-FAC to the blue socket on the main EE820 board.
- Place the cover on the EE820 so that the cut-out 3 matches the location of the blue connector.

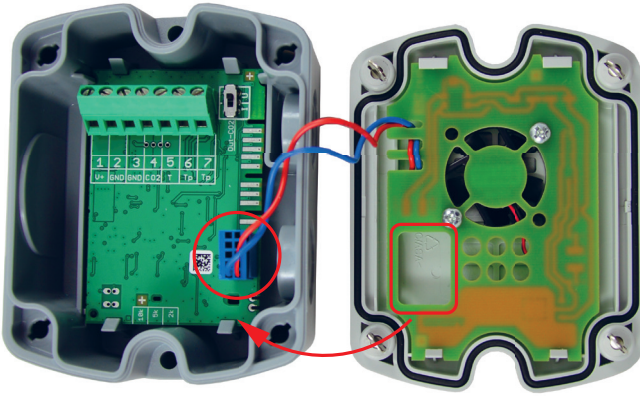

- Fix the cover with the 4 bayonett screws D.

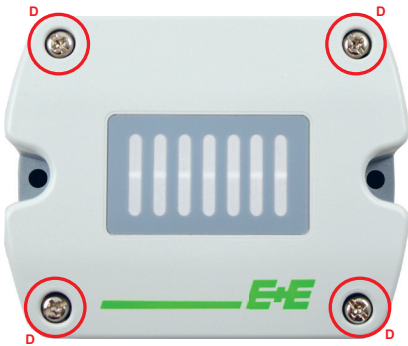

USA FCC notice:

This equipment has been tested and found to comply with the limits for a Class B digital device, pursuant to part 15 of the FCC Rules. These limits are designed to provide reasonable protection against harmful interference in a residential installation. This equipment generates, uses and can radiate radio frequency energy and, if not installed and used in accordance with the installation manual, may cause harmful interference to radio communications. However, there is no guarantee that interference will not occur in a particular installation. If this equipment does cause harmful interference to radio or television reception, which can be determined by turning the equipment off and on, the user is encouraged to try to correct the interference by one or more of the following measures:

- Reorient or relocate the receiving antenna.
- Increase the separation between the equipment and receiver.
- Connect the equipment into an outlet on a circuit different from that to which the receiver is connected.
- Consult the dealer or an experienced radio/TV technician for help.

CANADIAN ICES-003 Issue 5: CAN ICES-3 B / NMB-3 B

INFORMATION

+43 7235 605 0 / info@epluse.com

Langwiesen 7 • A-4209 Engerwitzdorf
Tel: +43 7235 605-0 • Fax: +43 7235 605-8
info@epluse.com • www.epluse.com

LG Linz Fn 165761 t • UID-Nr. ATU44043101
Place of Jurisdiction: A-4020 Linz • DVR0962759

