



Series EE240



**WIRELESS SENSOR FOR
HUMIDITY
TEMPERATURE
CO₂**

Manual

Hardware and Software



JLC International
Phone: 215-340-2650
Fax: 215-340-3670

948 Lenape Drive Town Center, New Britain, PA 18901
jlcusa@jlcinternational.com
www.jlcinternational.com

USA

FCC information:

This equipment is tested and in compliance with all requirements for category B concerning part 15 of the FCC regulations. These requirements have been set up to ensure an appropriate protection against EMC disturbances in residential areas. This equipment produces, consumes and can radiate high frequency energy. If not installed and used in accordance with the information in this manual, the EE240 series can cause EMC disturbance. There is no guarantee that EMC disturbance will not affect certain kinds of installations. If the equipment causes EMC disturbance during radio and television reception (to be determined by switching the equipment on and off), then it is recommended to take the following actions to eliminate the interference:

- Adjust or reposition the antenna
- Increase the distance between the receiving equipment and the wireless transmitter
- Connect the equipment to an outlet on a different circuit as that to which the receiver is connected
- Contact an experienced radio / TV technician

Caution:

Any changes or modifications made to the equipment, which are not carried out by a certified EMC technician may cause failure leading to malfunctions.

CANADA

ICES-003 notification:

This equipment complies with the norm ICES-003, category B.

TABLE OF CONTENTS

1.	GENERAL	4
1.1	<i>Symbol Clarification</i>	4
1.2	<i>Disposal note</i>	4
1.3	<i>Safety Instructions</i>	4
2.	PRODUCT DESCRIPTION	5
2.1	<i>Wireless Network</i>	5
2.1.1	General	5
2.1.2	Installation of a wireless system	6
2.1.3	Example for a wireless measurement setup	6
2.2	<i>Components of the series EE240</i>	6
2.2.1	Sensing Probe	6
2.2.2	Transmitter	6
2.2.3	Router	7
2.2.4	Basis Station	7
3.	FUNCTION DESCRIPTION / INSTALLATION	7
3.1	<i>Basis Station</i>	7
3.1.1	Installation	8
3.1.2	Electrical Connections	8
3.1.3	Operating Components	8
3.1.4	Webserver	9
3.1.5	Netzwerk Reset	9
3.2	<i>Transmitter, Sensing Probe</i>	9
3.2.1	Installation EE244	9
3.2.2	Electrical Connections EE244	10
3.2.3	Operating components EE244	11
3.2.4	Installation EE245	12
3.2.5	Electrical Connections EE245 - for external supply	12
3.2.6	Operating components EE245	13
3.3	<i>Router</i>	14
3.3.1	Installation	14
3.3.2	Electrical Connections	14
3.3.3	Operating Components	14
4.	STARTING UP THE WIRELESS SYSTEM	15
4.1	<i>“Point-to-Point” (EE241 with a single transmitter)</i>	15
4.2	<i>“Wireless Network” (EE242 with multiple transmitters)</i>	15
4.3	<i>Increasing the Transmission Distance with Routers</i>	15
5.	CALIBRATION OF MEASUREMENT SYSTEM	16
5.1	<i>Calibration of the EE244 Sensing Probes at E+E’s OEKD-Lab</i>	16
5.2	<i>Customer’s Calibration of the Humidity/Temperature Sensing Probes</i>	16
5.3	<i>Functional Test of the Entire Measurement System</i>	16
5.4	<i>Loop-Calibration</i>	16
6.	TROUBLESHOOTING / MAINTENANCE	17
6.1	<i>Replacing Sensing Probes</i>	17
6.2	<i>Troubleshooting</i>	17
7.	TECHNICAL DATA	18
8.	ERSATZTEILE / ZUBEHÖR	18
9.	GENERAL	19
10.	INSTALLATION	19
11.	CREATING AN ETHERNET CONNECTION BETWEEN PERSONAL COMPUTER AND EE242	19
11.1	<i>IP-address of the base station (default factory settings)</i>	19
11.2	<i>Setup of IP-address</i>	19
12.	MENU ITEMS	21
12.1	<i>Overview</i>	21
12.2	<i>Transmitters</i>	22
12.2.1	Transmitter List	22
12.2.2	Probe Status	23
12.2.3	Transmitter Status	23
12.3	<i>Outputs</i>	24
12.4	<i>Modbus Map</i>	25
12.5	<i>Management</i>	27
12.6	<i>About</i>	27

1. GENERAL

This manual is a part of the scope of supply and serves to ensure optimal operation and functioning of the equipment.

E+E Elektronik® Ges.m.b.H. cannot be hold responsible for the incorrect handling, installation, and maintenance of the equipment described in this publication. Therefore, it is necessary that this manual is read and understood by those responsible for the handling, installation, and maintenance of the equipment. This manual may not be used for competitive purposes or passed on to third parties without the written consent of E+E Elektronik® Ges.m.b.H. It is permitted to make copies for personal use.

This publication can contain technical inaccuracies or typographic errors. The content of this manual is updated on a regular basis and not subject to change. The manufacturer reserves the right to modify or change the equipment described in this manual without prior notice.

©Copyright E+E Elektronik® Ges.m.b.H.

All rights reserved

1.1 Symbol Clarification



This symbol indicates safety instructions.

The safety instructions have to be carried out unconditionally. If disregarded loss, injury, or damage may be inflicted to people and property. In any case E+E Elektronik® Ges.m.b.H. cannot be hold responsible.



This symbol indicates attention.

The note should be observed to achieve an optimal functioning of the equipment.

1.2 Disposal note



The crossed-out wheeled-bin symbol on your product, literature or packaging reminds you that all products must be taken to separate collection in the European Union. do not dispose of these products as unsorted municipal waste.

Return the products to collection to prevent possible harm to the environment or human health and support the sustainable reuse of material resources

1.3 Safety Instructions

General safety instructions



- Excessive mechanical stress and inappropriate handling must be avoided.
- Caution: the sensor element can be damaged when unscrewing the filter cap.
- The sensor element is an ESD-sensitive device; therefore, handling the sensor element ESD related precautionary measures have to be taken.
- Mounting, electrical installation, putting in operation and maintenance should only be done by qualified personnel.

Specific safety instructions for “Wireless”

Standards:

CE: Electromagnetic Compatibility according EN61326-1 and EN61326-2-3 / Industrial environment

FCC: Part 15 Class B

ICES: ICES-003 Class B

Transmission module:

Contains FCC ID:MCQ-XBEEPRO2

Contains Model XBee PRO Radio; IC: 1846A-XBEEPRO2

This equipment complies with Part 15 of the FCC Rules.

Operation is subject to the following conditions:

- this device may not cause harmful interference
- under direct influence of EMC interference the device must continue to function, including interference that may cause an undesired operational situation
-

Zulassungen		
United States (FCC Part 15.247)	FCC ID: OUR-XBEE2	FCC ID: MCQ-XBEEPRO2
Industrie Kanada (IC)	IC: 4214A-XBEE2	IC: 1846A-XBEEPRO2
Europa (CE)	ETSI	ETSI
Australien	C-Tick	C-Tick
Japan	R201WW07215215	R201WW08215142

FCC ID: MCQ-XBEEPRO2 (part 15 of the FCC regulations)

IC: 1846A-XBEEPRO2 (Canada accept FCC's audit report about the compliance with ICES-003)

Europe CE: CEPT ERC 70-03E / R&TTE Directive (no special marking, except CE)

**Specific Instructions:**

The transmission energy of the series EE 240 is limited according to certain standards, alterations of the electronics are therefore, with respect to the transmission license, prohibited.

Norway:

In the Svinsdal area is it not allowed to operate a device for radio communication.

USA:

The antenna must be mounted more than 20cm (8 inches) away from any human body.

2. PRODUCT DESCRIPTION

The wireless transmitter series EE240 combines modern sensor technology, easiest system installation and the highest reliability of the data transmission. The several different modules of the series EE240 are within a short time operational. No matter if it is a point-to-point connection or a comprehensive network, the series EE240 offers the ideal solution.

2.1 Wireless Network

2.1.1 General

The series EE240, based on the "ZigBee" protocol, transmits at a frequency of 2.4 GHz with a power of 10 mW. A bi-directional wireless connection prevents loss of data, if disturbances may occur. The maximum transmission distance depends greatly on the local conditions. Obstacles, like walls of reinforced concrete, steel buildings, or structures attenuate the signal and decreases the transmission distance.

2.1.2 Installation of a wireless system

In principle, in an ideal situation, the transmitter and the router resp. the base station should be within 'eyesight' to achieve an optimal strength of the signal. If that is not possible, a more appropriate location can be found using the features of the base station EE242, with the support of an amplifying router. The changes of the strength of the transmitter signal are indicated in a percentage (%), by the signal indicator on the web server of the EE242.

Sollten Hindernisse eine Funkverbindung zwischen Sender und Basisstation beeinträchtigen, können mittels Router diese Hindernisse umgangen und Funkstrecken verlängert werden. Eine „Reihenschaltung“ von Routern ist problemlos möglich.

Optimal positioning of a router:

- To reduce cost several different transmitters can be channeled over one router.
- The router should always be aligned with the weakest transmission connection.
- A maximum of 10 wireless connections per router / base station; see outline 2.1.3.

2.1.3 Example for a wireless measurement setup

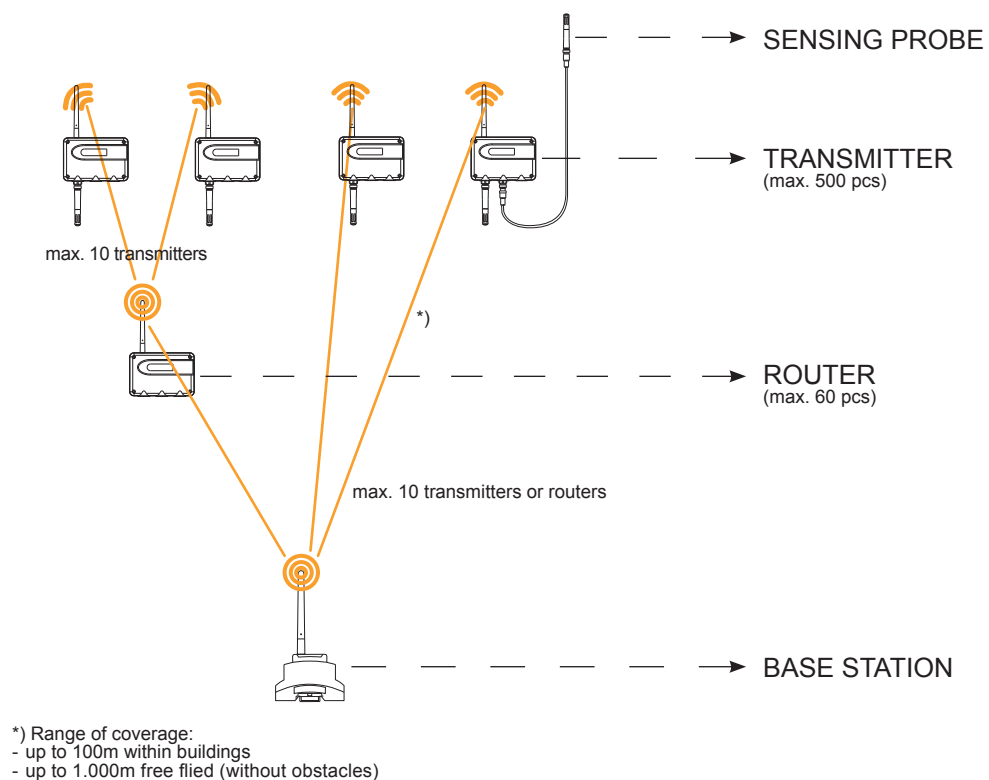

2.2 Components of the series EE240

2.2.1 Sensing Probe

There are several different sensing probes available, for the measurement of temperature, relative humidity, and carbon dioxide (CO₂). Each sensing probe has its calibration data stored internally, is therefore 100% interchangeable, and can be installed remotely with a sensor cable at up to 10m (33ft). For a detailed technical description, see chapter 3.2 Transmitter, Sensing Probe.

2.2.2 Transmitter

The transmitter powers the sensing probe and transmits wirelessly the measurement data. Each transmitter can be equipped with a maximum of three sensing probes. For a detailed technical description, see chapter 3.2 Transmitter, Sensing Probe.

2.2.3 Router

The router is designed to increase the overall transmission distance and to bypass obstacles. Each router has the ability to receive and transmit a maximum of 10 signals (transmitter or another router). It is not possible to connect measuring probes to a router. For a detailed technical description, see chapter 3.3 Router

2.2.4 Basis Station

The base station processes the data of the sensing probe and output an analogue or digital signal. Each base station has four analogue outputs and a (optional) display. The base station of the series EE240 does not have a data logger. For a detailed technical description, see chapter 3.1 Base Station.

3. FUNCTION DESCRIPTION / INSTALLATION

3.1 Basis Station

Depending on the application two different systems can be set up:

1) "Point-to-Point" (EE241 with a single transmitter)

This setup offers a cost friendly solution to transmit wirelessly a few measurement values (e.g. a temperature and a humidity measurement). The EE241 can communicate with only a single transmitter EE244, in between the two any desired number of routers can be installed to increase the transmission distance.

The EE241 has for each measured value only one channel available (temperature, humidity, CO₂). E.g. it is not possible to transmit two temperature signals simultaneously. There is no personal computer necessary to configure the EE241 – the desired setup is configured by E+E in accordance with the ordering code.

2) "Wireless Network" (EE242 with multiple transmitters)

With the EE242 a comprehensive wireless network can be build. The network can consist out of 500 transmitters and 50 routers. Each base station can receive a maximum of 10 signals (router or transmitter) The Ethernet interface, Modbus and Webserver allow for easy configuration of the system.

COMPARISON	EE241	EE242
Transmitter: maximum number of EE244 transmitters	1	500
Router: maximum number of routers EE244-R	60	60
Basis Station: Configuration of the analog outputs	ordering code	via WEB-Server
General configuration possible	-	via WEB-Server
Digital interface	-	Ethernet, Modbus

3.1.1 Installation

The housing can be installed on DIN-rail.

To remove from the rail, both orange snap locks can be opened with the use of a screwdriver.

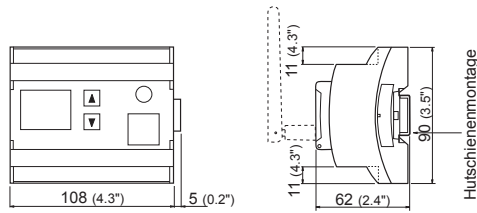

Pluggable antenna which can also be ordered with a remote cable (antenna cable refer to accessories)

3.1.2 Electrical Connections

Screw terminal assignment of series EE241 (Pins 6, 7 and 8 are not assigned) and EE242:

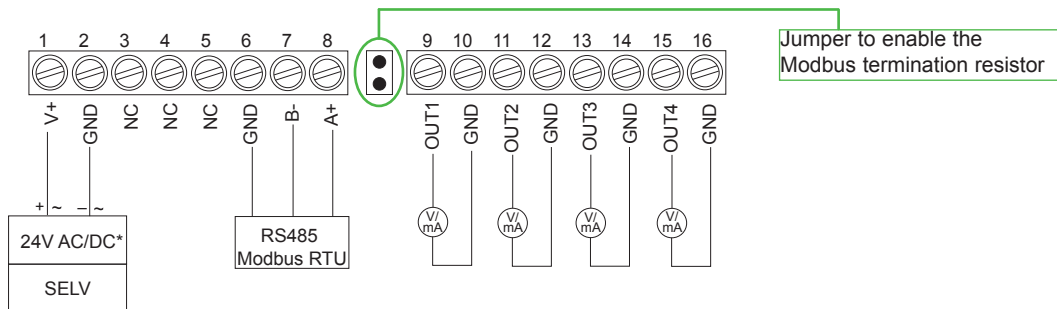

*) The supply circuit must be fused with $\leq 8A$

3.1.3 Operating Components

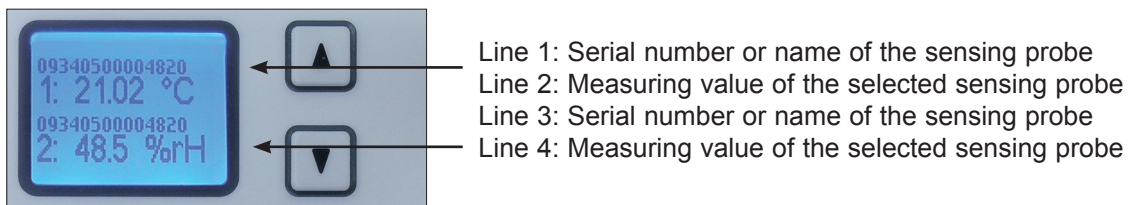
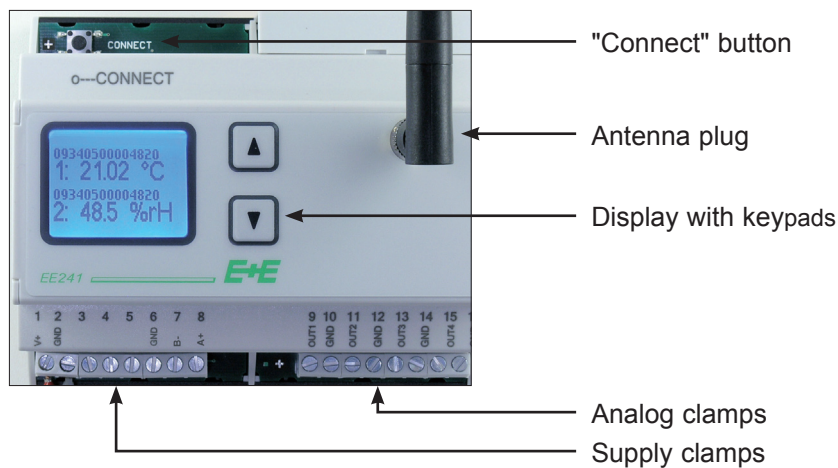

On the display of the Base Station only the measuring signals of those sensors are indicated, which are also available at the 4 analogue outputs.

3.1.4 Webserver

The EE242 can be set up with any desired configuration by means of the webserver; as a result one has full control of the entire network. The base station of the series E240 does not have a data logger. For a detailed technical description, see chapter „Configuration Software“.

3.1.5 Network Reset

To reset the system to the default factory settings, the push-button “Connect” should be pressed for 10 seconds.

- EE241: the wireless connection with the transmitter will be cancelled.
- EE242: all wireless connections (with transmitters and routers) will be cancelled.

All settings will reset to the default factory settings:

IP address of the base station, password of the web server, etc.

3.2 Transmitter, Sensing Probe

3.2.1 Installation EE244

Installation of fixed sensing probe:

The transmitter should be mounted in such a way that the probe points downwards.

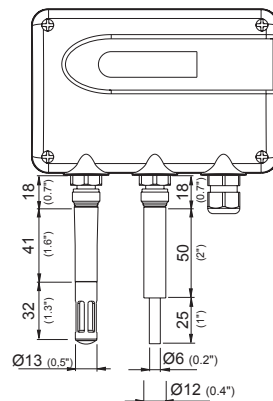

Installation a remote sensing probe:

The sensing probes can be installed remotely up to 10m (33ft).

For pluggable sensor cables (2m, 5m, and 10m) and radiation shields, see chapter 8, Replacement parts / Accessories.

During installation it is recommended to create a water-drip-off-bend in the cable.

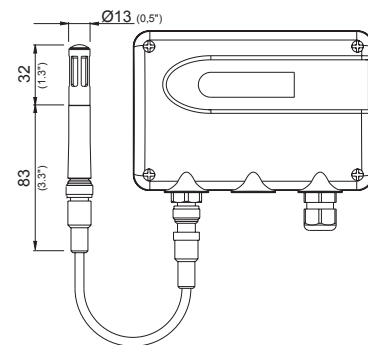

Installation of the housing:

1. Drill the mounting holes according to the drill template (see sketch). There is a special mounting kit available for the installation on DIN- rail (see chapter 8. Replacement parts / Accessories).
2. Mount the bottom part of the housing with 4 screws; less than 4.2mm in diameter (not in the scope of supply).
3. Connect the transmitter (see chapter 3.2.2 Electrical Connections).
4. Install the cover with 4 screws (in the scope of supply).

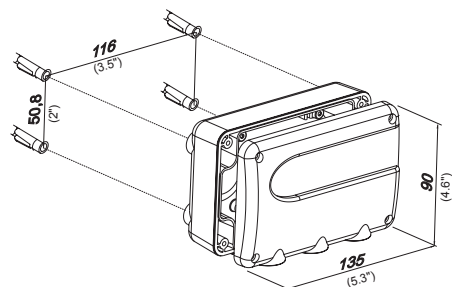

3.2.2 Electrical Connections EE244

Sensing probe

All available sensing probes have a matching 4-pin plug, to fit the connector on the transmitter housing. For further detailed information see the data sheet of the particular sensing probe.

Transmitter

Depending on the type ordered up to three sensing probes can be connected to the transmitter. By means of a pluggable sensor cable (optional) the probe can be installed remotely up to 10m (33ft). For pluggable sensor cables 2m (6ft), 5m (16ft), and 10m (33ft), see chapter 8, Spare parts / Accessories.



Pluggable Antenna

The transmitter EE244 is supplied with an assembled antenna. If needed the antenna can be unplugged and connected to an optional 2m (6ft) antenna cable and relocated. Antenna cable, see chapter 8, Spare parts / Accessories.

Power supply

- Transmitter "EE244-Axx" is supplied with four Alkaline, 1.5V, AA batteries
- Transmitter "EE244-Bxx" will accept an external power supply
Counterpart = specific straight cable female socket 4-pole (ELKA 4012 PG7)

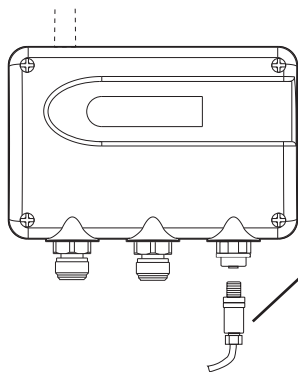

Pin assignment:

1	+Ub ¹⁾ 24V AC/DC ±20% SELV
2	n.c.
3	GND
4	n.c.

1) The supply circuit must be fused with $\leq 8A$



Battery change

- Open the cover on the sender (screwed).
- Use alkaline batteries. Make sure the batteries are inserted with correct polarity. Weak batteries should be replaced quickly to avoid running out of batteries.
- After successful launch of the transmitter close the cover carefully.

Attention:

Please do not dispose of old equipment and used batteries in domestic waste. Take them to the environmentally compliant disposal at designated collection points in accordance with national or local regulations

3.2.3 Operating components EE244

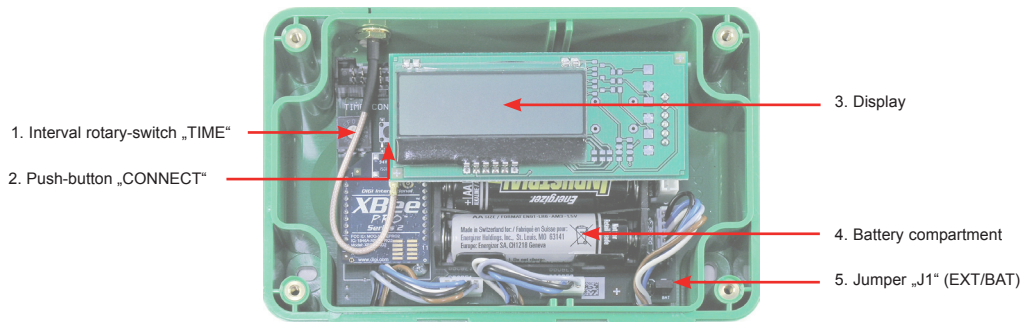

1. Interval rotary-switch "TIME":

With the rotary switch "TIME", the following transmission and measurement intervals can be selected:

Switch position	Interval	Switch position	Interval
0	20 sec.	A	45 min.
1	30 sec.	B	60 min. (1 hr)
2	45 sec.	C	90 min. (1,5 hr)
3	1 min.	D	120 min. (2 hr)
4	2 min.	E	180 min. (3 hr)
5 = default	5 min.	F	240 min. (4 hr)
6	10 min.		
7	15 min.		
8	20 min.		
9	30 min.		



Attention:

With the webserver (EE242 Base Station), any time interval can be configured. Selecting a time interval of less than 15 minutes for the transmitter will greatly reduce the operating life of the batteries. Typical operating life is up to 3 years, based on a transmission interval of 15 minutes (for T / %RH).

2. Push-button „CONNECT“:

To establish the initial connection between the base station and the transmitter. (For a detailed technical description, see chapter 4. "Starting up the Wireless System".) Additionally the status of "signal strength level [%]" can be activated temporary with this key. If you press the key for 1 sec while connecting the voltage supply (or the last battery is inserted) the EE244 shows the "signal strength level [%]" of the wireless connection for 60 sec before switching back to the normal display mode.

3. Display:

Place the display on the designated pins.
Display symbols:

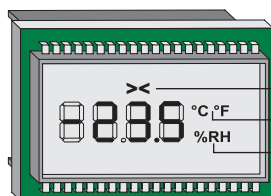

- >< This symbol is 'on' if the wireless connection is established and 'blinks' if the connection fails.
- °C / °F Unit of the chosen temperature value
- %RH Unit for rel. humidity (%RH)



On the display all available measured values (RH, T, CO2) of the sensors (up to 3) are alternatly indicated. Warning: The measured values are updated in the adjusted interval „TIME“ (see chapter 3.2.3.1).

4. Battery compartment:

Alkaline batteries, 4 off (1.5V, AA)

5. Jumper „J1“ (EXT/BAT):

The allocation of the jumper allows for the selection of 'battery power' or 'external power'.

3.2.4 Installation EE245

Opening the housing:

Press pin A until cover can be opened.

Closing the housing:

Set cover into flute B and move it to direction C until pin A snaps in.

Installation:

Mount housing on wall with screws through therefore designated holes D.

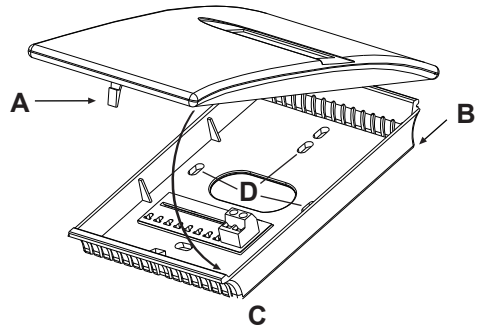

Material of housing: PC
Protection class: IP30

Dimensions

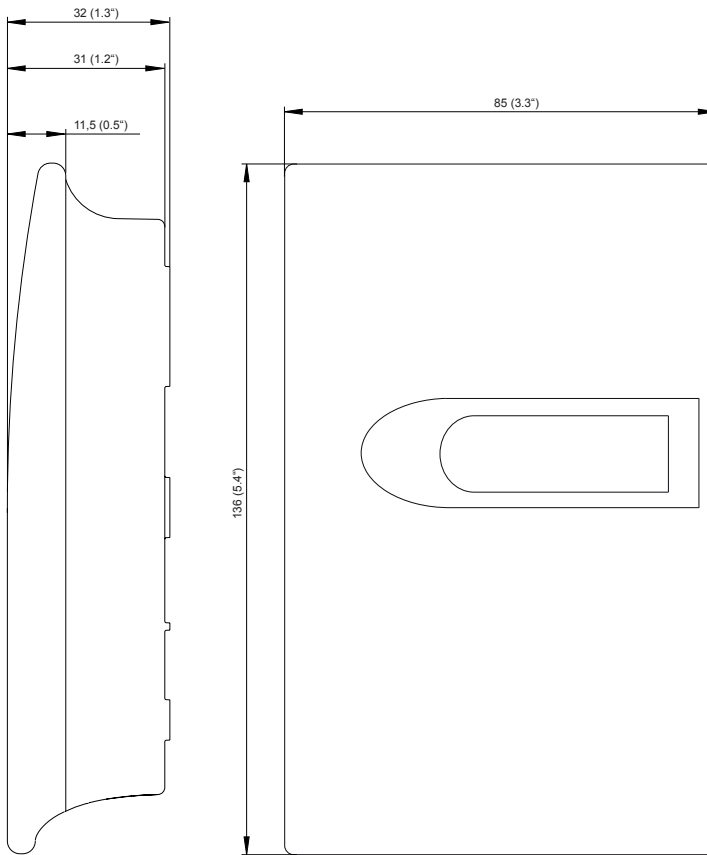

Mounting holes

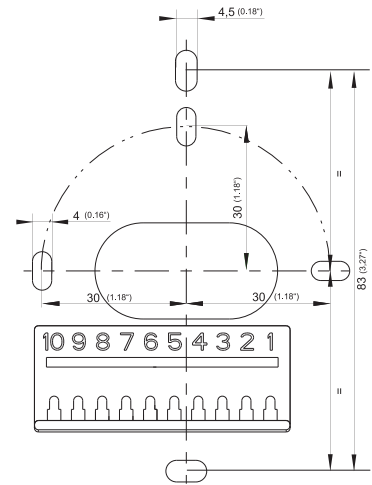

3.2.5 Electrical Connections EE245 - for external supply

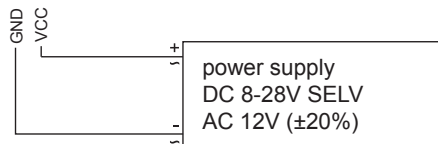

See page 10 for battery replacement.

3.2.6 Operating components EE245

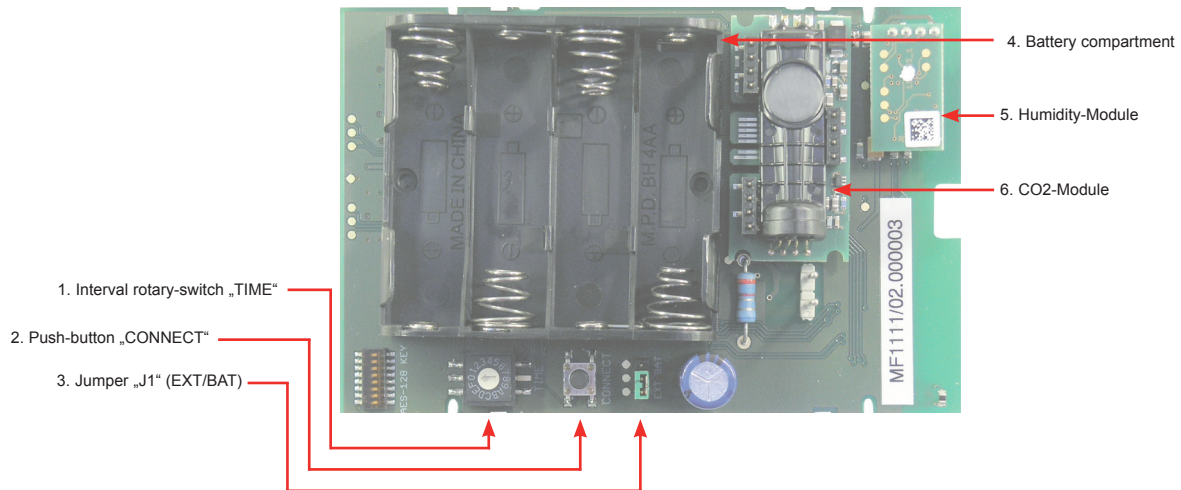

1. Interval rotary-switch "TIME":

With the rotary switch "TIME", the following transmission and measurement intervals can be selected:

Schalterposition	Intervall
0	20 Sek.
1	30 Sek.
2	45 Sek.
3	1 Min.
4	2 Min.
5 = Werkseinstellung	5 Min.
6	10 Min.
7	15 Min.
8	20 Min.
9	30 Min.

Schalterposition	Intervall
A	45 Min.
B	60 Min. (1 Std)
C	90 Min. (1,5 Std)
D	120 Min. (2 Std)
E	180 Min. (3 Std)
F	240 Min. (4 Std)



Attention:

With the webserver (EE242 Base Station), any time interval can be configured. Selecting a time interval of less than 15 minutes for the transmitter will greatly reduce the operating life of the batteries. Typical operating life is up to 3 years, based on a transmission interval of 15 minutes (for T / %RH).

2. Push-button „CONNECT“:

To establish the initial connection between the base station and the transmitter. (For a detailed technical description, see chapter 4. "Starting up the Wireless System".)

Additionally the status of "signal strength level [%]" can be activated temporary with this key. If you press the key for 1 sec while connecting the voltage supply (or the last battery is inserted) the EE244 shows the "signal strength level [%]" of the wireless connection for 60 sec before switching back to the normal display mode.

3. Jumper „J1“ (EXT/BAT):

The allocation of the jumper allows for the selection of 'battery power' or 'external power'.

4. Battery compartment:

Alkaline batteries, 4 off (1.5V, AA)

3.3 Router

The router is designed to increase the overall transmission distance and to bypass obstacles. Each router has the ability to receive and transmit a maximum of 10 signals (transmitter or another router). Sensing probes cannot be connected to the router.

3.3.1 Installation

For the installation of the router, see chapter 3.2.1. Installation of a transmitter.

3.3.2 Electrical Connections

The router is powered by an external power supply. Pin assignment of the female socket, see chapter 3.2.2. Electrical Connection (Transmitter), under "Power Supply".

3.3.3 Operating Components

- Jumper „J1“
- Push-button "Connect"

For details refer to chapter 3.2.3 Operating components (Transmitter).

4. STARTING UP THE WIRELESS SYSTEM

4.1 “Point-to-Point” (EE241 with a single transmitter)

There is no personal computer necessary to configure the EE241 – the desired setup is configured by E+E Elektronik in accordance with the ordering code.

Necessary steps to start up the system:

- 1) Establish the power supply to the base station.
- 2) Connect the sensing probe to the transmitter, either direct or with a sensor cable.
- 3) Establish the power supply to the transmitter (4 Alkaline 1.5 V, AA batteries, in the scope of supply). Remove the transportation insulation-strip in the battery compartment first, to activate the transmitter.
- 4) Establish the wireless connection: Press the push-button “Connect” for 3 sec.. Immediately the base station switches to the ‘Connect-Mode’ and searches for active transmitters – for 30 sec.. The LED next to the push-button lights up to indicate the ‘Connect-Mode’ is active. Within these 30 sec., the push-button “Connect” on the transmitter must be pressed for 3 sec. to establish a connection. As soon as the base station recognizes the wireless signal from the transmitter, the addresses of the devices are automatically exchanged and the wireless connection established.
- 5) Checking the active wireless connection:
Base station: The wireless connection is active, as soon as the measurement data is available (display, analogue output).
Transmitter: The wireless connection is active, as soon as in the display the symbol >< is continuously illuminated (see chapter 3.2.3. Operating Components, under 3. Display).
- 6) Alterations of the configuration of the transmitter: The transmission interval is set at a default of 5 minutes. To increase the operating life of the batteries the transmission interval can easily be altered with the rotary switch “TIME” in accordance with the interval-time table, see chapter 3.2.3 Operating Components, under 1. Rotary Switch “TIME”.

4.2 “Wireless Network” (EE242 with multiple transmitters)

For the configuration of the EE242 a personal computer is needed (with admin authorization), to manage all transmitters and to configure the analogue outputs of the base station.

- 1) Preparing the hardware:
Attention: the base station can handle a maximum of 10 wireless signals (transmitter or router). If more than 10 transmitters are needed, an extra router will extend the network further (for details, see chapter 3.3. Router).
- 2) Preparing the personal computer and software:
No disk space is needed on the personal computer, because the EE242 is equipped with a web server.
- 3) Configuration of the wireless network:
Connect the base station with the personal computer by way of the Ethernet connection and adjust the network settings (see chapter, Configuration Software).
 - Start the internet browser (Internet Explorer, Firefox,).
 - Enter the default IP-address (//192.168.0.64) of the EE242 in the address line.
- 4) Check the active wireless connection, see chapter 4.1 “Point-to-Point” (EE241 with a single transmitter), under 4).
- 5) Changing the configuration settings of the transmitter and the base station, see chapter Configuration Software.



4.3 Increasing the Transmission Distance with Routers

In order to register the transmitter EE244 to the network through the router the following steps have to be taken:

a) Register the router:

Press the push-button “Connect” on the base station for 3 sec.. Within 30 sec., the push-button “Connect” on the router must be pressed for 3 sec. to establish a connection. As soon as the base station recognizes the wireless signal from the router, transmitters can be added and connected through the router.

b) Register transmitters to the network through the router:

Press the push-button “Connect” on the base station for 3 sec. Within 30 sec., the push-button “Connect” on the transmitter must be pressed for 3 sec. to establish a connection. As soon as the base station recognizes the wireless signal from the transmitter, the addresses of the devices are automatically exchanged and the wireless connection established.

5. CALIBRATION OF MEASUREMENT SYSTEM

5.1 Calibration of the EE244 Sensing Probes at E+E's OEKD-Lab

Any of the sensing probes can be sent to E+E's OEKD-lab for calibration.

5.2 Customer's Calibration of the Humidity/Temperature Sensing Probes

a) Calibration software on the personal computer:

The calibration can be done by means of software on a personal computer → see respective product data sheet.

b) For all EE07 sensing probes by use of EE220 transmitter:

The calibration of the RH and T outputs is done by means of the calibration buttons on the board of the EE220 humidity/temperature transmitter. For details, see manual EE220 and in chapter 8. Replacement Parts / Accessories.

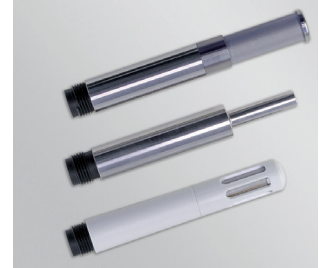

A humidity calibrator is needed in order to perform an accurate humidity calibration (e.g. E+E's "Humor 20", see chapter 8. Replacement Parts / Accessories).

5.3 Functional Test of the Entire Measurement System

It is possible by utilizing reference probes (fixed output value) to test the entire measurement system. A reference probe, available as an accessory (incl. calibration certificate / see chapter 8. Replacement Parts / Accessories), is used to test the function and accuracy of the measurement loop.

Both reference probes, with a fixed output value for humidity and temperature, are connected to the transmitter instead of the standard interchangeable sensing probes. The reference probes simulate a high humidity and a low temperature value and vice versa, in order to test the high and low end of the scales of the analogue outputs.



5.4 Loop-Calibration

The loop calibration of the humidity and temperature outputs, as recommended by the FDA for the pharmaceutical and biotech industry, can easily be realized with separate humidity and temperature sensing probes (type EE07). E+E's "Humor 20" can be utilized as the high accurate humidity calibrator (see chapter 8. Replacement Parts / Accessories).

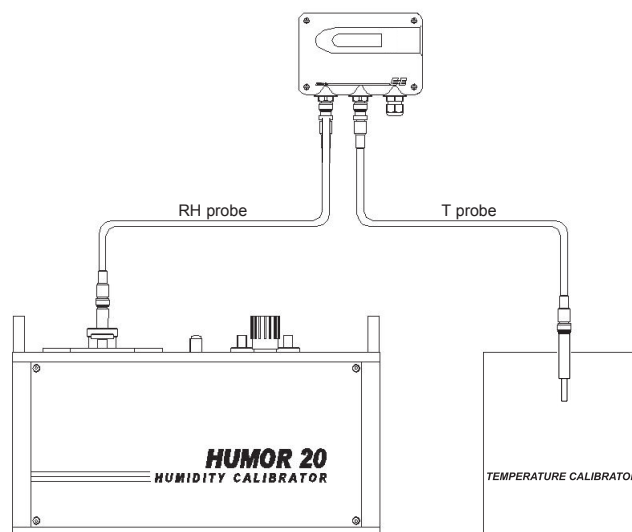

6. TROUBLESHOOTING / MAINTENANCE

6.1 Replacing Sensing Probes

If a sensing probe is damaged (e.g. mechanically damaged,...), the user can replace the probe with a new one without any adjustment of the transmitter. This way an elaborate process of returning the equipment to the factory will be avoided.

Procedure to replace a sensing probe:

- 1) Remove the faulty sensing probe.
- 2) Connect the new replacement probe.
- 3) In addition, the webserver of the base station EE242 offers the possibility to manage the sensing probes (see chapter Configuration software).

6.2 Troubleshooting

Error

possible cause

- ▶ Action / Correction

Sensing probe measures incorrectly

Error during recalibration of the transmitter

- ▶ Reset to default factory settings and repeat the calibration procedure.

Filter cap dirty

- ▶ Replace filter cap

Sensor faulty

- ▶ Replace sensing probe

Long response time

Filter cap dirty

- ▶ Replace filter cap

Wrong filter cap

- ▶ Replace with suitable filter cap for the application.

Transmitter failure

Interrupted power supply or weak batteries

- ▶ Check the wiring of the power supply resp. test the batteries. If the batteries are replaced within 7 days after the failure, the system will automatically restart. If the batteries are replaced after 7 days, it suffices to press the push-button "Connect" at the base station to restore the connection.

Too high humidity value

Condensation at the tip of probe

- ▶ Dry out the probe tip and check if the probe is mounted in the correct way.

Wrong filter cap

- ▶ Replace with suitable filter cap for the application.

Failure of the wireless connection

Interrupted power supply or weak batteries

- ▶ Check the wiring of the power supply resp. test the batteries.

New erected obstacles (metal structures ...) attenuate the wireless signal

- ▶ Bypass the obstacles utilizing additional router(s).

Forgot password

- ▶ Reset the base station E242 to the default factory settings (IP- address, Password,..) see chapter 3.1.5. Network Reset.

7. TECHNICAL DATA

Measuring values of sensing probes

Refer to data sheet of respective sensing probes

General

Transmission frequency	2.4 GHz		
Transmission system	IEEE 802.15.4		
Transmission power	10mW		
Radio range	up to 100m (330 ft) indoors, up to 1000m (3300 ft) in open field		
Antenna	pluggable		
Approval	ETSI / FCC Part 15.247 / IC		
Electromagnetic compatibility	EN61326-1 Industry	FCC Part 15 Class B	
	EN61326-2-3 Industry	ICES-003 Class B	
Pollutional index 2			
Devices of measurement category II			
Protection Class III (SELV)			
Installation altitude up to 2000 m above sea level			

EE244 (Transmitter, Router)

Supply transmitter (EE244-A)	battery 4x1.5V AA		
Battery lifetime	> 1 year with a measuring data transmission every 5 min. (for T / %RH)		
External supply transmitter (EE244-B)	8...28V DC SELV, typ. IL = 20mA at 24V; max. IL = 35mA at 24V DC		
External supply router (EE244-R)	8...28V DC SELV, typ. IL = 20mA at 24V; max. IL = 35mA at 24V DC		
Power consumption	typ. 0.5VA; max. 0.8VA		
Housing material	polycarbonate (PC)		
Protection class housing	IP65		
Temperature ranges	working temperature range of probe:	refer to respective data sheet	
	working temperature range:	-40...+50°C (-40...122°F) (with display: -20...+50°C / -4...122°F)	
	storage temperature range:	-40...+50°C (-40...122°F) (with display: -20...+50°C / -4...122°F)	
Max. number of sensing probes	3 (2)*		
Max. number of measuring signals	6 (4)*		

EE241/EE242 (Base Station)

Supply voltage SELV	24V AC/DC ±20%		
digital interface	Ethernet		
	Modbus (RTU / ASCII / TCP)1)		
Current consumption	EE241	typ. IL = 70mA at 24V DC; max. IL = 100mA at 24V DC	
	EE242	typ. IL = 150mA at 24V DC; max. IL = 180mA at 24V DC	
Power consumption	EE241	typ. 1.7VA; max. 2.4VA	
	EE242	typ. 3.6VA; max. 4.3VA	
Analogue outputs	0-5V	-0.5mA < IL < 0.5mA	
	0-10V	-1mA < IL < 1mA	
	0-20mA / 4-20mA	RL < 500 Ohm	
Number of analogue outputs	4		
Accuracy of analogue outputs	±5mV resp. ±10µA		
Temperature dependence of analogue outputs	max. 0.1 $\frac{mV}{°C}$	resp. 1 $\frac{\mu A}{°C}$	
	Resolution of analogue outputs 0.7mV resp. 1.50µA		
Electrical connection	screw terminals max. 2.5mm ²		
Housing material	polycarbonate (PC)		
Protection class housing	IP20		
Temperature ranges	working temperature range:	-30...+50°C (-22...122°F) (with display: -20...+50°C / -4...122°F)	
	storage temperature range:	-30...+50°C (-22...122°F) (with display: -20...+50°C / -4...122°F)	

*) with external supply

1) from Q3/2011

8. ERSATZTEILE / ZUBEHÖR

Sensing probes:

- membrane filter	HA010101
- PTFE filter	HA010105
- metal grid filter (polycarbonate)	HA010106
- metal grid filter (stainless steel)	HA010109
- replacement probe RH/T in metal	EE07-MFTx
- replacement probe RH/T in polycarbonate	EE07-PFTx
- replacement probe T in metal	EE07-MTx
- replacement probe T in polycarbonate	EE07-PTx
- radiation shield for EE07	HA010502
- reference probes EE07 RH/T	HA010403
- replacement probe CO ₂ in polycarbonate	EE871-Cxxx*
- reference probe CO ₂	
HA01xxxx*probe cable for remote sensing probe	
- 2m (7ft)	HA010801
- 5m (16ft)	HA010802
- 10m (33ft)	HA010803
- device for adjustment for RH, T-probes	EE220-xxx2x
- humidity calibrator	Humor 20

* (ab Q3/2011 verfügbar)

Transmitter, Router:

- bracket for rail installation	HA010203
- external power supply unit	V02

Base station:

- antenna cable, 2m (7ft)	HA010330
- crossover cable (PC to base station)	HA010333
- external power supply unit	V02

CONFIGURATION SOFTWARE

LIMITED LIABILITY

E+E Elektronik® is not liable for any direct or consequential damages (for example, but not restricted to loss of earnings, interruption of business, loss of information and data or any other financial losses), which result from the installation, usage and also impossibility of usage of a software product from E+E Elektronik® and any associated support or non-performance of support.

9. GENERAL

In addition to the control keypad on the optional display, the web-server of the EE242 (configuration software) offers a user-friendly possibility to configure the base station and the entire wireless network. System requirements are a modern internet browser (Internet Explorer, Mozilla Firefox ...) and an Ethernet connection with the base station. In order to setup a smooth configuration of the base station through the Ethernet (network address), admin authorization may be necessary.

10. INSTALLATION

Because of the integrated web server of the EE242 (configuration program) there is no need to install additional software.

11. CREATING AN ETHERNET CONNECTION BETWEEN PERSONAL COMPUTER AND EE242

11.1 IP-address of the base station (default factory settings)



IP-address of EE242-Basis Station:	192.168.0.64
Subnet Mask:	255.255.255.0

11.2 Setup of IP-address

1. STEP:

In order to establish communication between the personal computer and EE242, the IP-address of the personal computer has to be altered to fit the IP-number range of the EE242 base station.

For example Windows XP:

[start] ► Systemsteuerung ► Netzwerkverbindungen

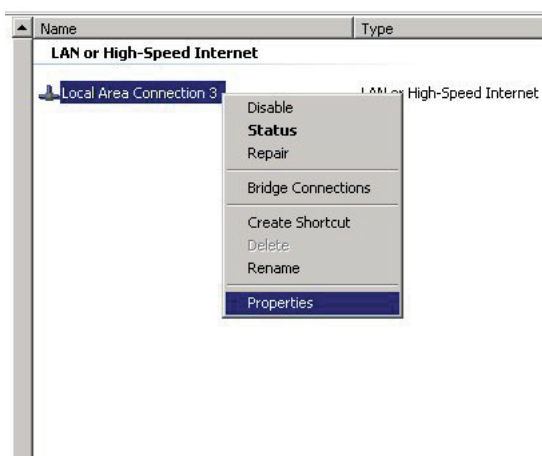

Right-click „Local Area Connection“ a click Properties"

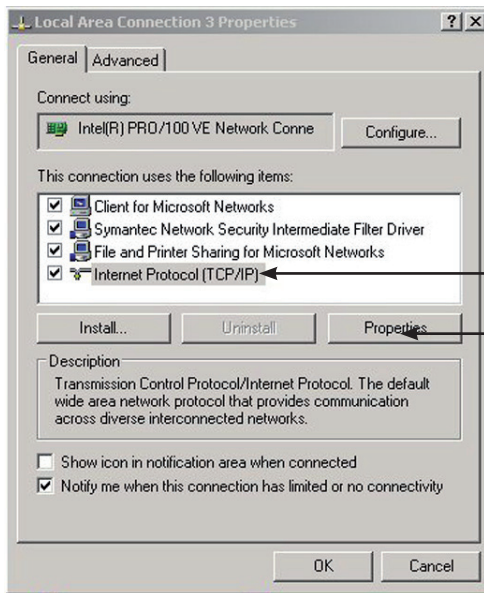

In the dialog box “Local Area Connections Properties” point at “Internet Protocol (TCP/IP)” and click the button “Properties”.

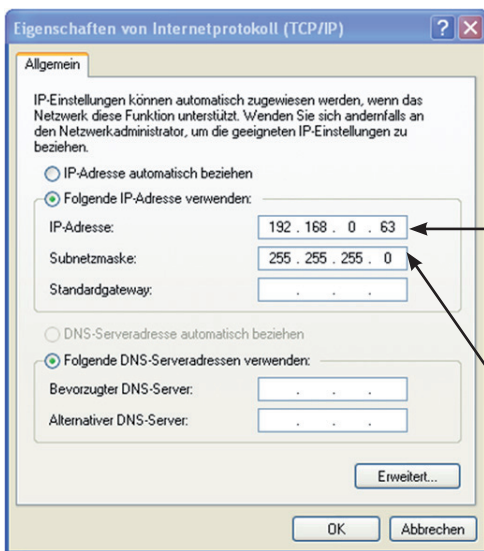

Check “Use the following IP-address” and change the computer IP-address to 192.168.0.X (choose X between 33 and 63).

192.168.0.64 is already used by EE242!

Enter in the “Subnet Mask” field ‘255.255.255.0’ and click the “OK” button to save the setup.

2. STEP:

- Connect the personal computer and EE242 with the “crossover cable” (PC-EE242: HA010333) or log both in to the same network.
- Establish power to the EE242.
- Start the internet browser and enter the IP-address of the base station: <http://192.168.0.64>
- Enter “Username” and “Password” - the following profiles are already entered by the factory:



- nur Leserechte:		
Benutzername	=	reader
Kennwort	=	reader
- Administrator Rechte:		
Benutzername	=	admin
Kennwort	=	admin

- As soon as the password has been entered the web server platform will start automatically. Several configurations can be altered under the menu item “Management”, e.g. the IP-address of the EE242 base station or the password for Username “Reader” and “Admin” (for details see chapter 12.4. Management)



12. MENU ITEMS

12.1 Overview

Shows an overview of the wireless network and its components

E+E YOUR PARTNER IN SENSOR TECHNOLOGY
ELEKTRONIK
DESIGN & IT

Overview Transmitters Outputs Modbus Map Management About Help

Overview

Status

Transmitter Status:	OK	Warn
Output Status:	OK	Alert
Modbus Status:	OK	OK

Transmitters

Number of Transmitters:	1
Number of Routers:	0
Total:	1

Base Station

Model:	EE242
Serial Number:	10279317006848
Up-Time:	32 days 23 h 47 min 28 sec
WebServer Firmware:	1.10
Controller Firmware:	1.15
MAC Address:	00:40:9D:41:DE:D5
IP Address:	172.26.200.5 (Manual)
Subnet Mask:	255.255.0.0
Default Gateway:	0.0.0.0

Status of the entire wireless network

“Warn” - warning
“Alert” - alarm / failures have occurred
“OK” - the entire network functions properly

Transmitters:

Line 1: number of active transmitters
Line 2: number of active routers
Line 3: total number of active transmitters and routers

Base Station:

Line 1: model number
Line 2: serial number of the base station
Line 3: elapsed time since last interruption



Webserver:

All indicated data are updated in a 5sec-interval.

12.2 Transmitters

Listing of the active routers and transmitters.



Overview Transmitters Outputs Modbus Map Management About Help

Transmitters

Transmitter List

Status	Data Age	Name	Serial Number	Type	Interval	
OK	3 min 34 sec	CM-Labor	10359310004756	TM	5 min	Edit

Transmitter List
(chapter 12.2.1)

Details (of the last valid transmission)

Name: CM-Labor, Serial Number: 10359310004756

Probe Status					
Status	Data Age	TM-Port	Probe	Measurand	Measured Value
OK	3 min 34 sec	1	EE07 103405000455C4	Temperature	25.70 °C
				Humidity	35.3 %rH

Transmitter Details

Probe Details
(Chapter 12.2.2)

Transmitter Status		
Status	Property	Value
OK	Battery:	6.46 V
n/a	Signal:	80 %
n/a	Firmware:	1.15
n/a	Up-Time:	59 sec

Transmitter Status
(Chapter 12.2.3)

12.2.1 Transmitter List

- Status:** here are three conditions: OK / WARNING / ALERT
The following can result in a change of the status:
- xxx = Time since the last transmitting (status of wireless connection)
- the level of the power supply
- Data Age:** Indicates the time elapsed since the transmission of the last measurement data.
- Name:** Editable name of the transmitter (can be changed by the user [admin]).
- Serial Number:** Serial number of the transmitter (factory set).
- Type:** TM = transmitter
Router = router
- Interval:** Indicates the selected time interval of the transmission.
The transmission interval can be setup with the rotary switch "TIME" (chapter 13.2.3 Operating Components, under 1. Interval rotary switch "TIME") or direct from the web server. The change to the new selected transmission interval will take place at the next interval, and until that moment shown between brackets.
For example: current interval = 30 sec, new interval = 10 min.

Transmitter List

Status	Data Age	Name	Serial Number	Type	Interval	
OK	23 sec	EE244_Room31	Test_1004_00003	TM	30 sec (10 min)	Edit

Edit: One can change the configurable data (name, transmission interval); store with "Save Changes". To leave the edit-menu, click the hyperlink [„Back to Transmitters“](#)

12.2.2 Probe Status

If clicked in the 'Transmitter List' on the hyperlink "Name" or "Serial Number", the details of the selected transmitter will be shown in the bottom part of the screen. Depending on the transmitter model up to three sensing probes can be connected.

Shows all available data of sensing probe 1:

Status: There are three conditions: OK / WARNING / ALERT, see chapter 12.1 Overview.

Data Age: Indicates the elapsed time since the last transmission of measurement data
 Meaning of the Status:

- „OK“ - the wireless connection functions w/o failures
- „Warn“ - the last two data transmissions failed
- „Alert“ - several data transmissions failed



TM-Port: Indicates to which port the sensing probe is connected (see sketch).

Probe: Type of sensing probe and serial number.

Measurand: Indicates the active measurement parameter of the sensing probe (Temperature, Humidity, CO2,...).

Measured Value: Last transmitted measured value.

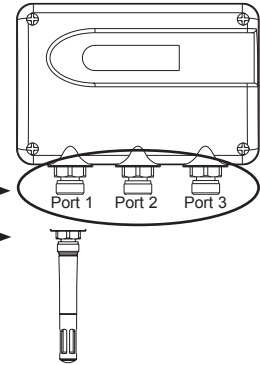

More transmitter details will be listed as soon as more sensing probes are connected to the transmitter.

Replacement of a sensing probe:

If a sensing probe has to be replaced (e.g. calibration, etc...), this can be done in a few easy steps:

- 1) Disconnect the old sensing probe.
- 2) Connected the new sensing probe.
- 3) Remove the old sensing probe from the system by clicking "[Delete Probe](#)".

Transmitter Details

Name: EE244_Plant_024/18, Serial Number: Test_1004_00004

Status	Data Age	TM-Port	Probe	Measurand	Measured Value
Alert	1 min 31 sec	1	EE07 101405000192BA Delete Probe	Temperature	23.04 °C
				Humidity	50.2 %rH
OK	3 sec	1	EE07 1016050000347A	Temperature	25.47 °C
				Humidity	45.0 %rH

12.2.3 Transmitter Status

Battery: Indication of the battery power, resp. "Ext. Power" if power supply is external.

Threshold values:

- > 4,6V OK
- 4,3-4,6V WARNING
- < 4,3V ALERT ► failure of the transmitter



Signal: Indication of the wireless signal strength.

Firmware: Software version of the transmitter.

Up-Time: Elapsed time since the last interruption.

12.3 Outputs



Overview	Transmitters	Outputs	Modbus Map	Management	About	Help
----------	--------------	---------	------------	------------	-------	------

Outputs

Analog Outputs

Status	Data Age	#	Current Value	Assigned To	Serial Number	Port	Measurand	Unit	Phys. Range	Type	Range	Failsafe Value	
OK	1 sec	1	24.03 °C	Transmitter	gh1003_0001_2346	any	Temperature	°C	0..100 °C	Voltage	0..10 V	0.00 V	Edit
OK	1 sec	2	49.2 %rH	Probe	--- any ---	n/a	Humidity	%rH	0..100 %rH	Voltage	0..10 V	0.00 V	Edit
OK	infinite	3	n/a	Probe	--- any ---	n/a	--- No Measurand ---	n/a	0..10000 n/a	Voltage	0..10 V	0.00 V	Edit
OK	1 sec	4	12.70 °C	Probe	--- any ---	n/a	Dew point (Td)	°C	0..100 °C	Voltage	0..10 V	0.00 V	Edit

Each analogue output can be configured by clicking on “Edit”:

In general there are two methods to map a measurement signal to an analogue output:

- “mapping the special port ‘X’ of a transmitter ‘Y’ to an analogue output”. This configuration always maps the measurement signal of port ‘X’ to the output. In addition, it does not matter if the sensing probe is replaced by another one of the same type (e.g. calibration cycle or replacement of the probe).
- “mapping a specific sensing probe (with a defined serial number) to an analogue output. This configuration maps ONLY this specific sensing probe to the analogue output. In addition, it does not matter to which transmitter the sensing probe is a connected.

Overview	Transmitters	Outputs	Management	About
----------	--------------	---------	------------	-------

Edit Output Configuration

Output: 1

Assigned To:	<input type="text" value="Transmitter"/>	1. Mapping the selected measurement signal
Serial Number:	<input type="text" value="gh1003_0001_2346"/> (empty = any Probe/Transmitter)	
Transmitter Port:	<input type="text" value="255"/> (1..3 = specific Transmitter Port, 255 = any Port)	2. Setup of ranges and values
Measurand and Unit:	<input type="text" value="Temperature [°C]"/>	
Physical Range:	<input type="text" value="0"/> .. <input type="text" value="100"/> °C	
Output Type:	<input type="text" value="Voltage"/>	
Custom Range:	<input type="text" value="0"/> .. <input type="text" value="10"/> V	
Failsafe Value:	<input type="text" value="0"/> V	
<input type="button" value="Save Changes"/> <input type="button" value="Back to Outputs"/>		

1. Mapping the selected measurement signal:

Example (a): “mapping an EE07 sensing probe at port 2 of the transmitter ‘10045689788’

- Assigned to: Select “Transmitter”.
- Serial Number: Enter the serial number of the desired transmitter.
The serial number can be copied and paste from the transmitter list (see chapter 12.2.1 Transmitter List) with ‘Ctrl’+‘C’ and ‘Ctrl’+‘V’.
- Transmitter Port: Select the transmitter port (see chapter 12.2.2 Transmitter Details, under “TM-Port”) to which the sensing probe is connected.
(Port 1, 2 or 3, resp.” 255”, if only one port is occupied, but the port number is unknown)

Beispiel (b): „EE07-Messfühler mit der Seriennummer „0909500001055D“ abbilden“

- Assigned to: Select “Probe”.
- Serial Number: Enter the serial number of the sensing probe.
The serial number can be copied and paste from the “Transmitter Details” of the transmitter list (see chapter 12.2.1 Transmitter List) with ‘Ctrl’+‘C’ and ‘Ctrl’+‘V’.
- Transmitter Port: Enter „255“.

2. Setup of ranges and values:

- Measurand and Unit: Selected desired measuring value (T, RH ...).
- Physical Range: Enter desired range and engineering unit of the measured value (e.g. 0 ...100 °C).
- Output Type: Indicates the physical output quantity (factory setting according to order code).
- Custom Range: Analogue output value, to represent the “Physical Range” as indicated above.
- Failsafe Value: Default analogue output value if a transmission failure / alarm is present.

12.4 Modbus Map



Overview Transmitters Outputs Modbus Map Management About Help

Modbus Register Map

Registers

Status	Data Age	#	Current Value	Assigned To	Serial Number	Port	Measurand	Unit	Failsafe Value	Data Type	Factor	Offset	Reg.Value	
OK	6 sec	1	21.89 °C	Transmitter	1035931000207f (EE244-09)	2	Temperature	°C	999.00 °C	Integer (16 bit)	100	0	2189	Edit
OK	6 sec	2	42.6 %rH	Transmitter	1035931000207f (EE244-09)	any	Humidity	%rH	500.0 %rH	Integer (16 bit)	100	0	4256	Edit

[Add new Modbus Register](#)

Via the link „Add new Modbus Register“, new registers / variables can be created.

Register Number:	<input type="text" value="16"/>
Assigned To:	<input type="text" value="Probe"/>
Serial Number:	<input type="text"/> (empty = any Probe/Transmitter)
Transmitter Port:	<input type="text" value="n/a"/> (1..3 = specific Transmitter Port, 255 = any Port)
Measurand and Unit:	<input type="text" value="-- No Measurand -- [n/a]"/>
Failsafe Value:	<input type="text" value="0"/> n/a
Data Type:	<input type="text" value="Float (32 bit)"/>
Factor:	<input type="text" value="1"/>
Offset:	<input type="text" value="0"/>
<input type="button" value="Create Register"/> Back to Modbus Register Map	

- Register Number: Is incremented automatically, but can be changed any time.
- Assigned to: Here you select whether a sensor or a transmitter will be mapped to the register.
(Details see 12.3. Outputs → Mapping the selected measurement signal)
- Serial Number: Type in the serial number of the probe or transmitter.
(can be copied from the transmitter list (see section 12.2))
- Transmitter Port: Type in transmitter port (see section 12.2.2)
- Measurand and Unit: Adjust desired measurement (T, RH ,...).
- Failsafe Value: Output value, which should be issued for a (transmission) error/alarm.
- Data Type: Select data type (Float, Integer,...)
- Factor: Possible multiplication factor for the register value
(Reg.Value = Current Value * Factor)
- Offset: Possible offset for the register value
(Reg.Value = Current Value * Factor + Offset)
- Create Register: The register will be created with the selected configuration.

Erase of applied registers:

Using "Edit", the configuration of each register can be changed. (in the list „Modbus Register Map“) Via the button „Delete Register“ the selected register will be deleted.

Edit Modbus Register Configuration

If Modbus Register is no longer needed:

Register Number:	<input type="text" value="2"/>
Assigned To:	<input type="text" value="Probe"/>

Basic settings Modbus:

Main menu ► Management ► Modbus:

Modbus

Byte Order:	<input type="text" value="MSB First (Big Endian)"/>	Basic settings
Float counts as:	<input type="text" value="2 Registers (1 Register = 1 WORD)"/>	
TCP Address:	<input type="text" value="0"/> (1..247, 0 = disabled)	for Modbus-TCP
Serial Address:	<input type="text" value="0"/> (1..247, 0 = disabled)	for Modbus-RTU
Serial Mode:	<input type="text" value="RTU"/>	
Baudrate:	<input type="text" value="9600"/>	
Parity:	<input type="text" value="Even"/>	
Databits:	<input type="text" value="8"/>	

12.5 Management



Overview Transmitters Outputs Management About

Management

Wireless Network

Open System: Always accept Connect requests
 Closed System: Accept Connects only for limited time (Connect button)
Default Connect duration: (5..254) Seconds

Connect duration: (5..254) Seconds



Wireless Network

- „Open System“: in this mode the base station is always in “Connect Mode” and can accept at any given time a ‘connection request’ from an E+E transmitter.
Attention: if two wireless systems are built parallel to each other a separation of the clients cannot be controlled
- „Closed System“: in this mode the base station must be switched to “Connect Mode” before it can accept ‘connection requests’ (see chapter 4, Starting Up the Wireless System).

Cable Network

IP Address Assignment:
IP Address:
Subnet Mask:
Default Gateway:

Cable Network

IP Address Assignment:

- Manual (static IP): enter or change manually the IP-address of the base station
- Automatic (DHCP): the IP-address will be obtained automatically from the DHCP-server

Settings Backup / Restore

Backup (Download Link appears after page reload)
Restore

Setting Backup/Restore

This feature allows to save all settings to a Backup-File on the PC to restore the old settings in case of an accidental reset to “factory settings” (see section 3.1.5).

Passwords

Admin	Username: <input type="text" value="admin"/>	New Password: <input type="text"/>	Repeat Password: <input type="text"/>	<input type="button" value="Set"/>
Reader	Username: <input type="text" value="reader"/>	New Password: <input type="text"/>	Repeat Password: <input type="text"/>	<input type="button" value="Set"/>

Passwords

Here the login-designation (admin, reader) and the password can be changed.

12.6 About



Overview Transmitters Outputs Management About

About

Company Information

E+E Elektronik Ges.m.b.H
Langwiesen 7
4209 Engerwitzdorf
AUSTRIA
Phone: +43 7235 605-0
FAX: +43 7235 605-8
E-Mail: info@epluse.at
Web: <http://www.epluse.at>

Copyright

Copyright (c) 2010 by E+E Elektronik Ges.m.b.H.
All rights reserved.

Built using [POCO C++ Libraries](#).